

# **KERRICK®**

## **OPERATING & MAINTENANCE MANUAL**

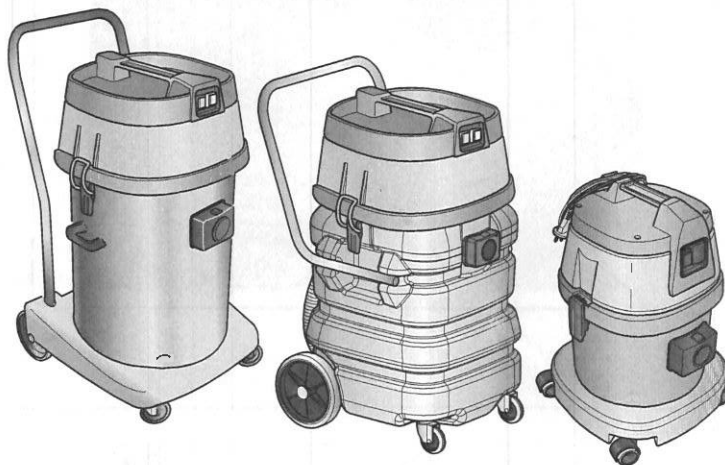

## **COMMERCIAL WET & DRY VACUUM CLEANERS**

**VAC 10 - VAC 10 L - VAC 27 L - VAC 27 PE  
VAC 59 L - VAC 59 PE - VAC 60 PE**

**Read Safety & Operating Instructions  
Before Commencing Operation**



## Liquid suction

For appliances equipped with suitable accessories.

- Release the levers (5 Fig. 2) and remove the cover (6 Fig. 3) complete with the motor unit.
- Remove the polyester filter (8 Fig. 4) if present.
- Remove the paper bag (7 Fig. 4) if present.
- Place the cover back on and lock it using the levers (5 Fig. 2).
- Insert, as far as possible, the sleeve (11 Fig. 6) of the suction hose into the nozzle (12 Fig. 6) on the drum.
- To release the sleeve (11 Fig. 6) press and hold the button (13 Fig. 6) and then pull out the sleeve (11 Fig. 6).
- Merge the ergonomic handle (15 Fig. 7) or hose (16 Fig. 7) depending on the model, with the extension (14 Fig. 7).
- Connect the two rigid extensions (17-18 Fig. 8) by aligning the two reference points (19-20 Fig. 8).
- Mount on the rigid extension (21 Fig. 9) the desired accessory, ( vacuum nozzle, floor nozzle etc..)



### NOTES:

For models equipped with ergonomic handle it is possible to adjust the suction force acting the nut (22 Fig. 10).

By opening the little window (23 Fig. 10) you get a lower suction force.

## USING THE APPLICANCE

- The device is equipped with wheels and thus can be moved with the proper handles, or it can be pushed with the help of the handle (26 Fig. 12)
- To lift it up insert your fingers under the dedicated handle (28 Fig. 13) on the top of the cover of the single version motor or lift with the help of two people using the handles (27 Fig. 12).

## Starting up the appliance

- Insert the plug (29 Fig. 14) into the socket.

### Single motor

- Press the switch (30 Fig.15) to position "I" to start the vacuum engine; lights, if located on the switch will turn on.

### Double motor

- Depending on the power required it is possible to start only one motor by pressing the switch (30 Fig. 15) on "I" or both switches (30 e 31 Fig. 15) if a greater suction force is required. Lights, if located on the switch will turn on.



### NOTES:

When the recovery tank is full, the noise intensity increases and the device can no longer aspire. Then you must switch off the device and empty the tank as described in the relevant paragraphs.

## Switching off the appliance

- Push the switches (30, 31 Fig. 15) to the "0" position to stop the device; the lights, if any on the switches, will go off.
- Remove the plug (29 Fig. 14) from the electrical socket.
- Wind up the cable (33 Fig. 16) and hook it onto its housing (32 Fig. 16).

## CLEANING AND MAINTENANCE



### DANGER:

**Before performing any maintenance operation, unplug the appliance from the electrical socket.**

1	2	3	4
Manufacturer	Model	Article	Container capacity

5	6	7	8
Vacuum	Air flow	Serial N°	Electrical characteristics

<b>PROBLEM</b>	<b>CAUSE</b>	<b>SOLUTION</b>
The vacuum cleaner does not work.	Switch not pressed.	Press the switch.
	Plug not inserted.	Insert the plug into the socket.
	No current.	Check the power supply line.
Suction is not satisfactory.	Paper bag full.	Replace the dust bag.
	Filter elements clogged.	Clean the filter elements.
	Accessories or tubes clogged.	Check and clean the flexible hose and the suction nozzle.
	Suction nozzle squeegee worn or damaged.	Check and replace the squeegee.

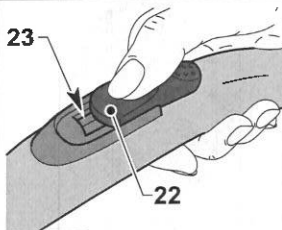

Fig. 10

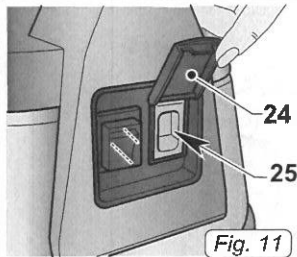

Fig. 11

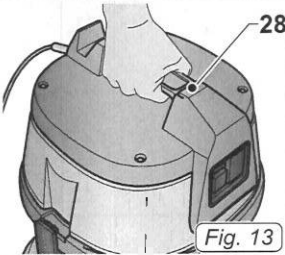

Fig. 13

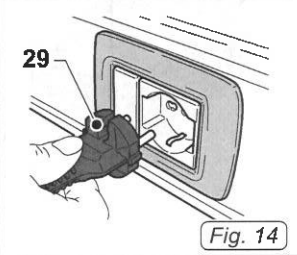

Fig. 14

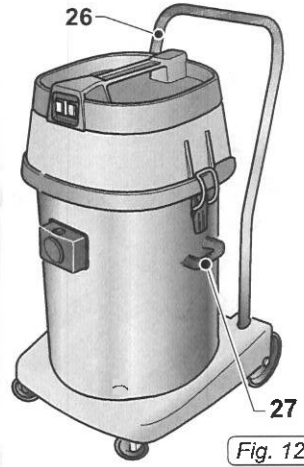

Fig. 12

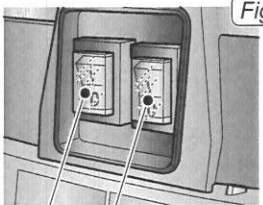
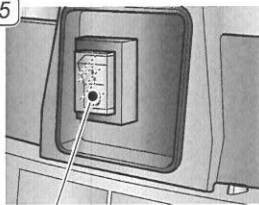

Fig. 15



30 31

30

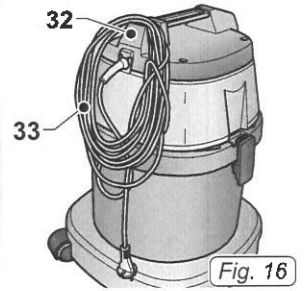

Fig. 16

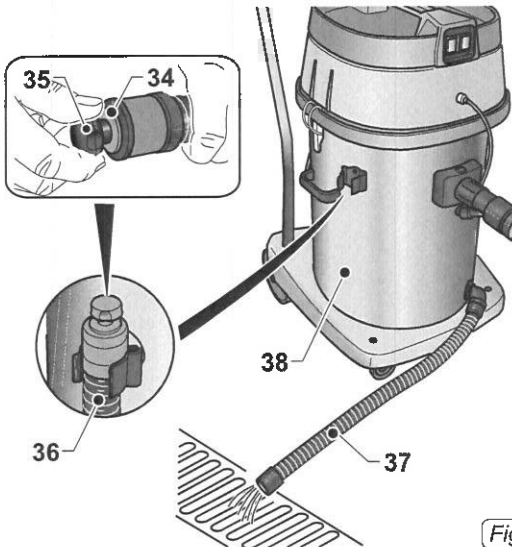

Fig. 18

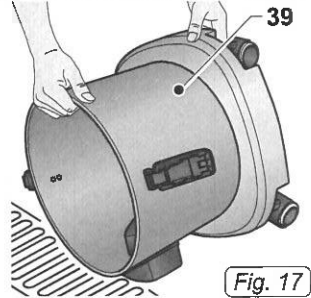

Fig. 17

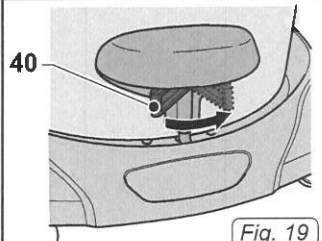





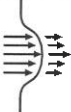
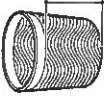
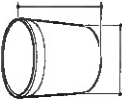



Fig. 19



										
VAC 10	■		See data plate	1200 W	60 dbA	160 mbar	10 l	410 x 410 x 560	8,8 kg	Ø 36 mm
VAC 10 L	■	■		1200 W	62 dbA	190 mbar	10 l	410 x 410 x 560	9,2 kg	Ø 36 mm (P) Ø 40 mm (Auto)
VAC 27 L	■	■		1200 W	62 dbA	190 mbar	25 l	410 x 410 x 760	9,7 kg	Ø 40 mm
VAC 27 PE	■	■		1200 W	62 dbA	190 mbar	25 l	410 x 410 x 760	9,7 kg	Ø 40 mm
VAC 59 L	■	■		2400 W	65 dbA	190 mbar	56 l	610 x 520 x 920	20 kg	Ø 40 mm
VAC 59 PE	■	■		2400 W	65 dbA	190 mbar	56 l	620 x 480 x 930	23,1 kg	Ø 40 mm
VAC 60 PE	■	■		3600 W	66,5 dbA	205 mbar	56 l	620 x 480 x 930	25,6 kg	Ø 40 mm



DEALER

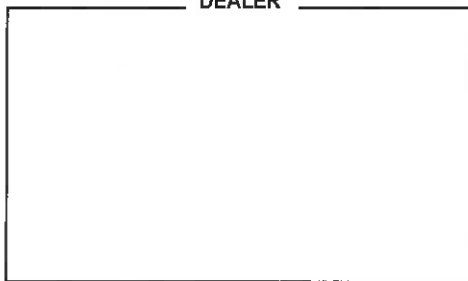

Cod. 8050885 - 1ª ed. - 03/2019

**KERRICK**

14 Lidco Street  
Ardell Park, NSW 2148 Australia

Phone: (02) 9737 9797

Fax: (02) 9737 9898

[www.kerrick.com.au](http://www.kerrick.com.au)